

1 Turn off the general Switch

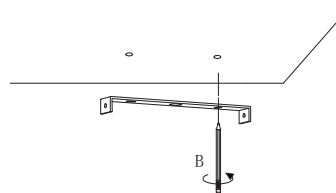

2 Align, where screws should be

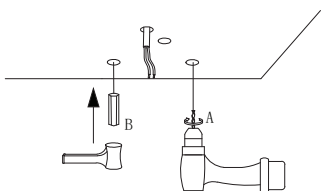

3 Apply plastic anchors

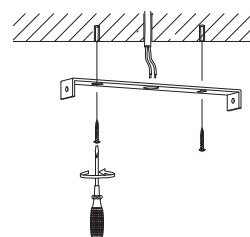

4 Apply screws to make it stable

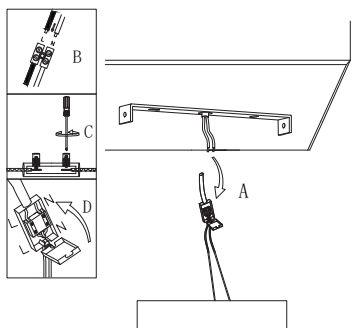

5 Connect the wires

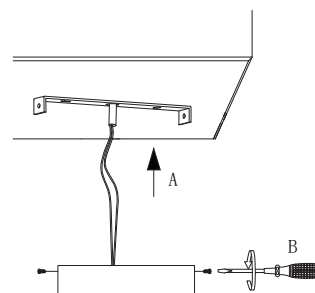

6 Apply the side screws

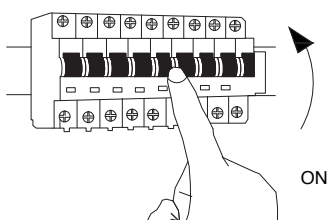



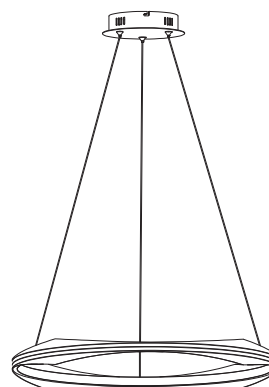



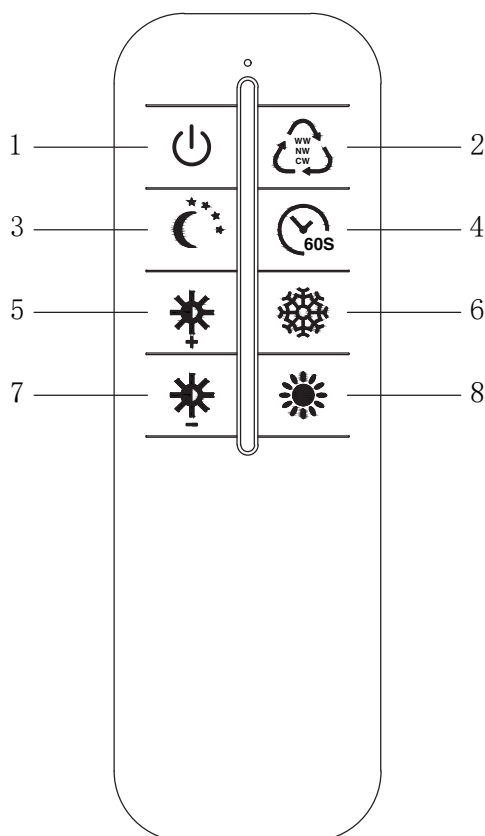

7 Turn on the general Switch



2.4G Remote control instructions



1.  ON/OFF switch. Switch on light, within three seconds and press this button once, if the light flash three times, the pairing is successful.
2.  Color temperature switch: Yellow-Warm white-White.
3.  Nightlight mode: 10% brightness of Yellow light.
4.  Timing mode: Switch off the light after 60s.
5.  Brightness +: when the lamp is on, press and hold this button down to increase the brightness.
6.  Color temperature change gradually: Hold down this button, color to White.
7.  Brightness -: when the lamp is on, press and hold this button down to decrease the brightness.
8.  Color temperature change gradually: Hold down this button, color to Yellow.