

NOVA LUCE

9088148

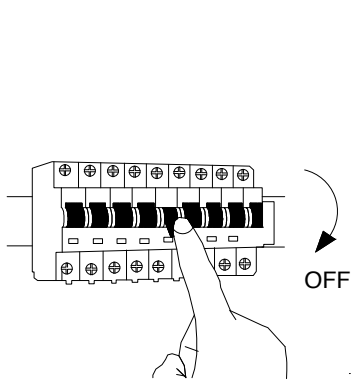

1. Turn off the general Switch

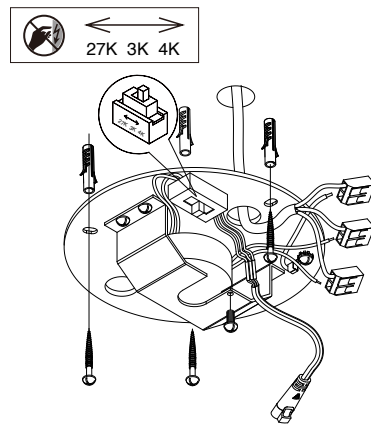

2. Apply plastic anchors & fix the screws to make it stable

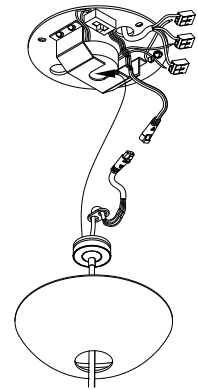

3. Insert the pendant onto place for connecting the wires

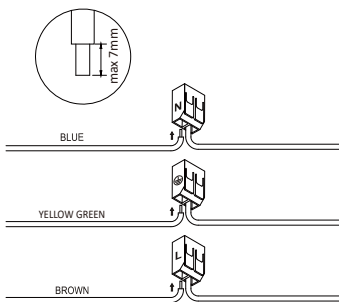

4. Connect the 3 wires

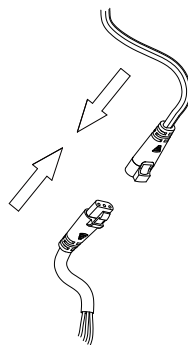

5. Plug wires in, by clicking them

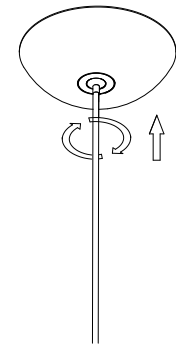

6. By rotating, apply the canopy

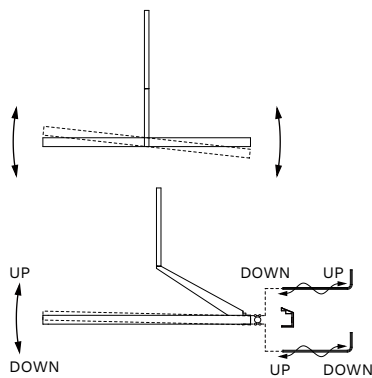

7. Adjust the lamp body to a horizontal position

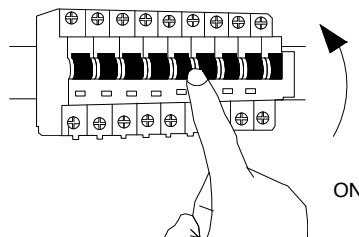

8. Turn on the general Switch

