

Turn off the general switch

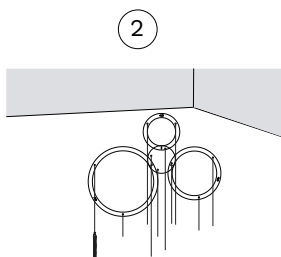

Mark where to drill holes

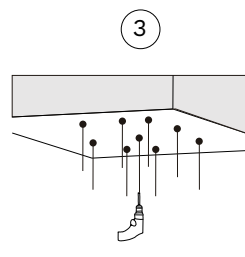

Drill on the marked areas

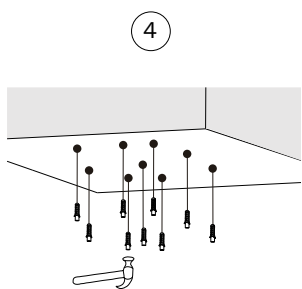

Apply plastic anchors

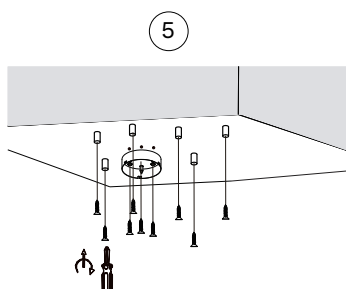

Apply screws

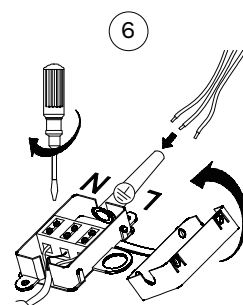

Connect the wires

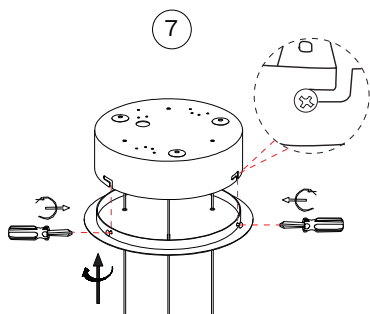

Apply side screws and make Hanging elements stable

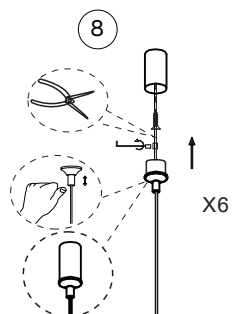

Adjust the wire & fix it into place

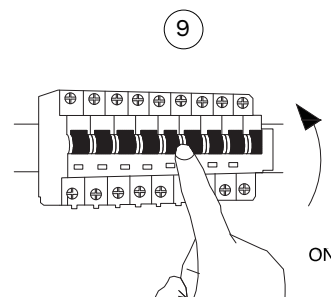

Turn on the general switch

